

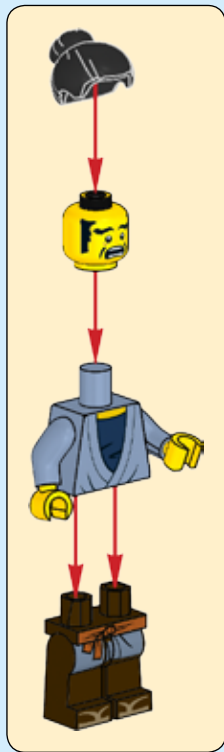

# THE NINJAGO MOVIE

70610

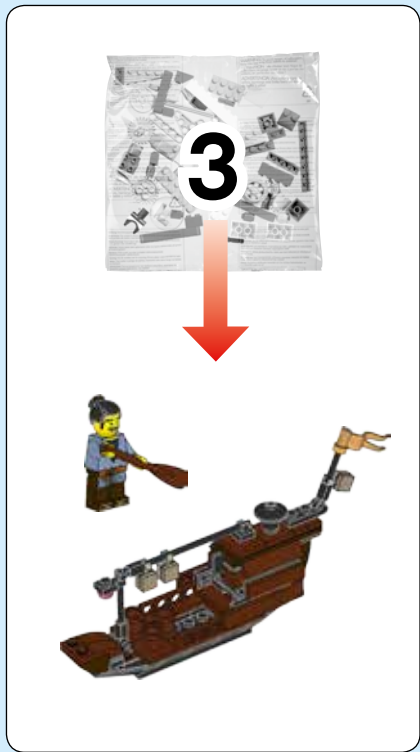



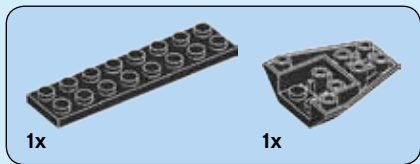

**1**

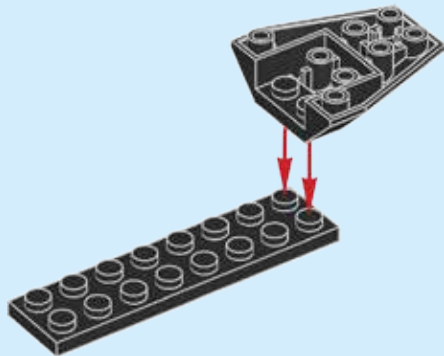

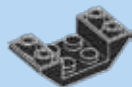

3x

2

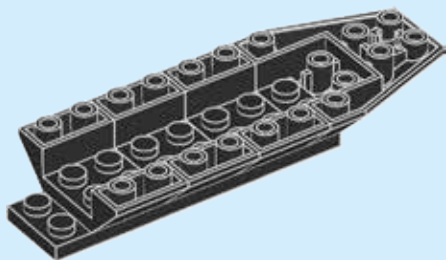

4

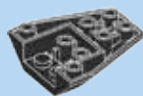

1x

3

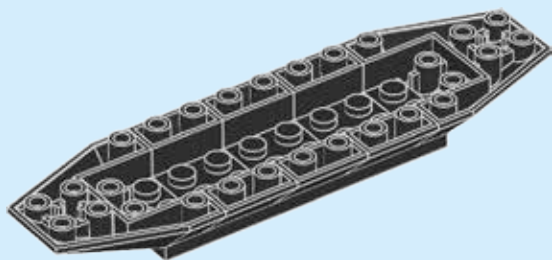



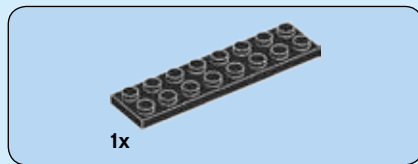

4

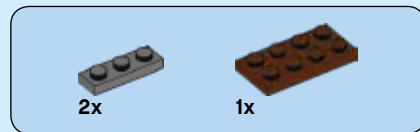
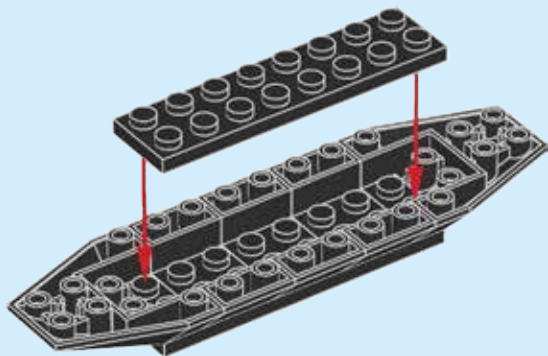

5

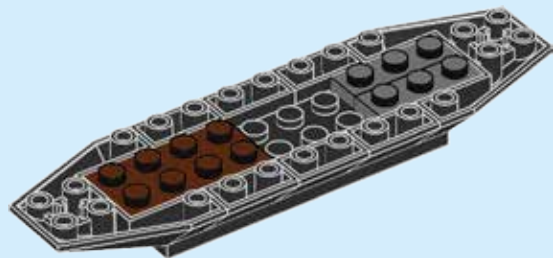

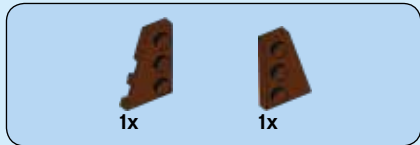

6

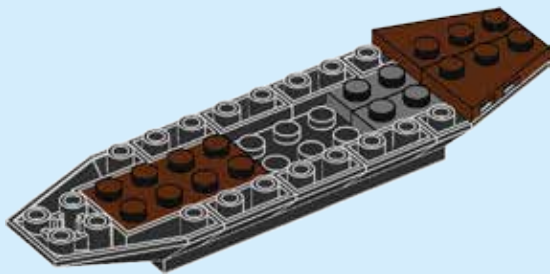

6



7

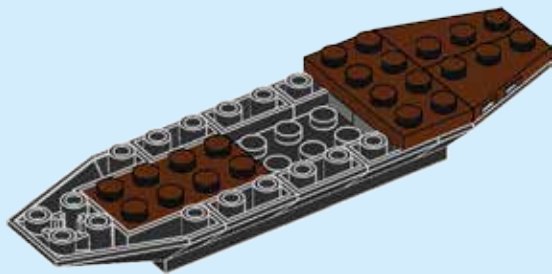



8

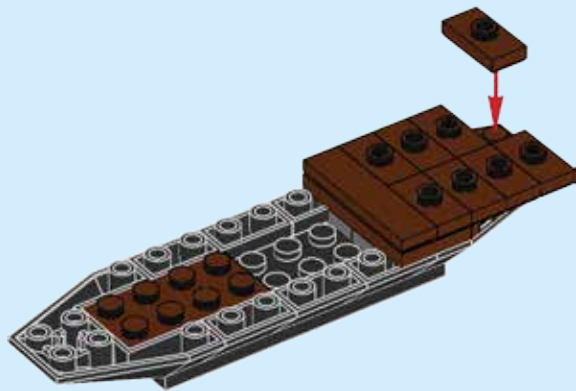

9

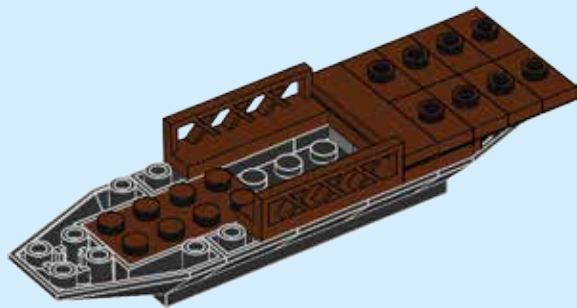

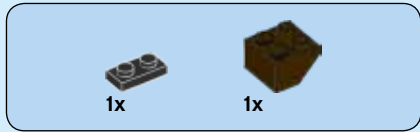

10

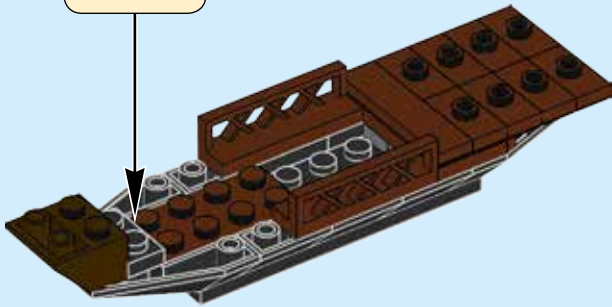

11

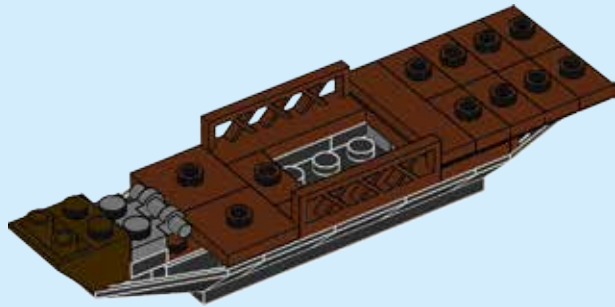



2x

12

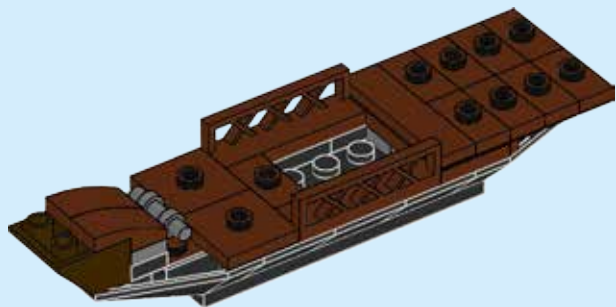

1x

13

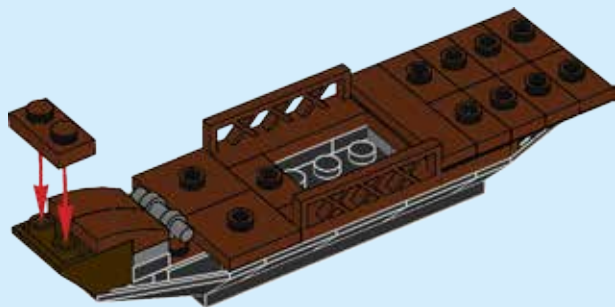



4x

14

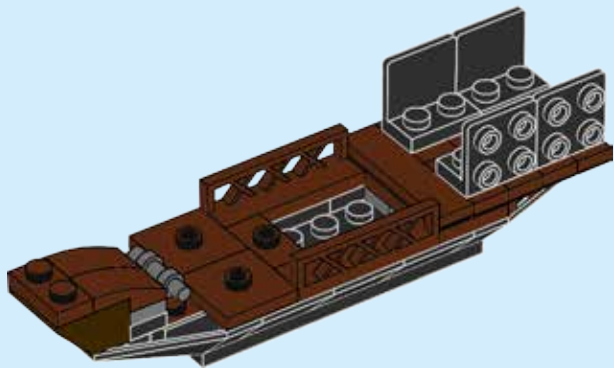

10



1x

15

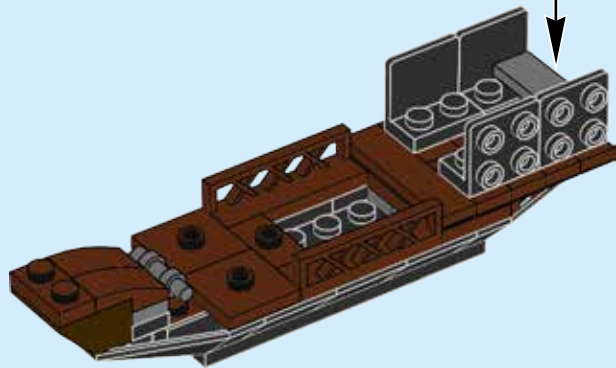





1x

**16**

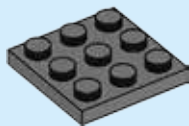

2x

**17**

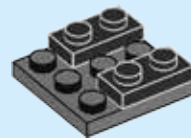



18

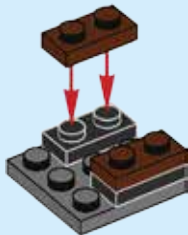

12



19

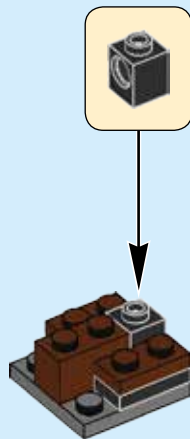



1x

20

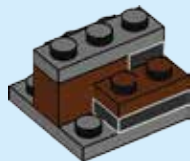

1x



1x

21

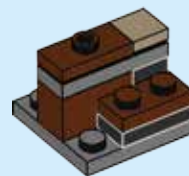



2x



2x

22

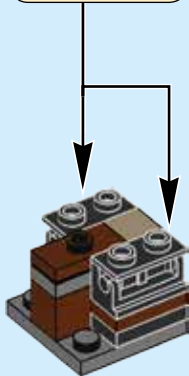
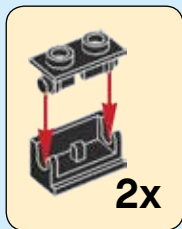

23

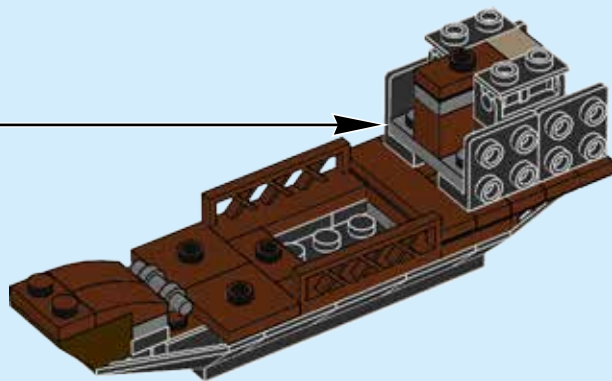

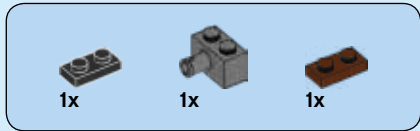

24

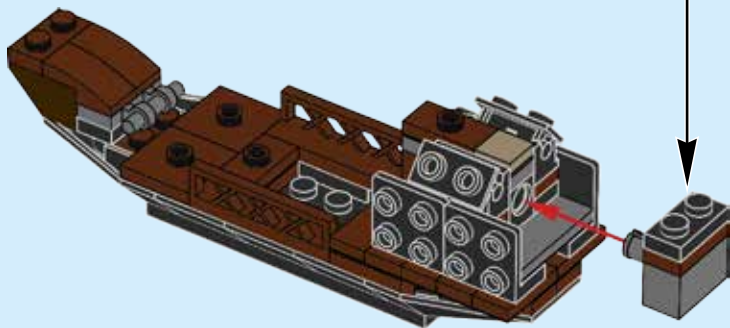
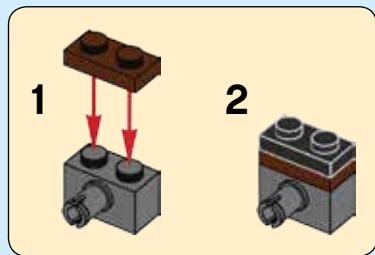

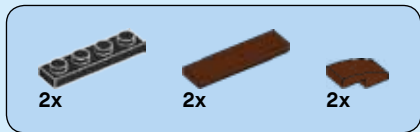

25

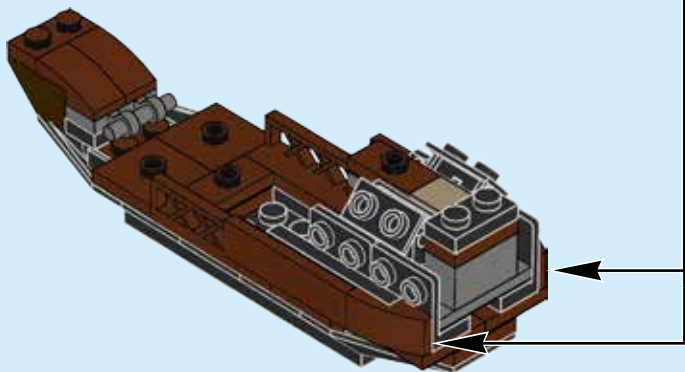
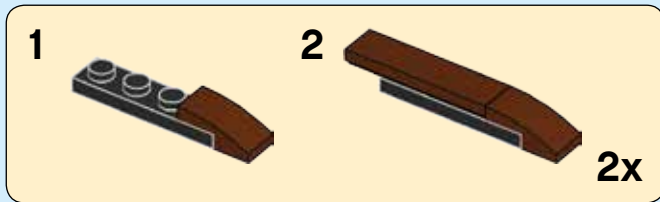





26

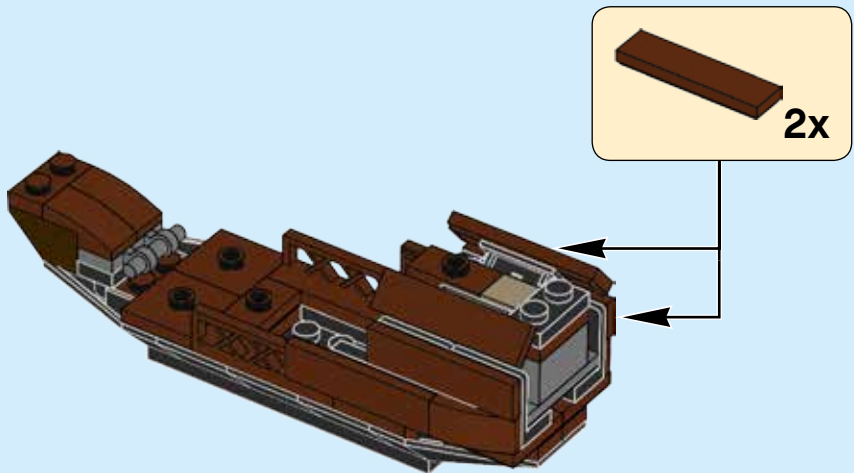



27

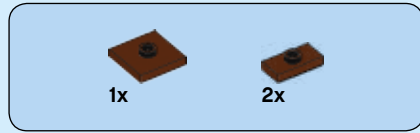
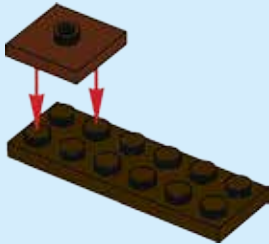

28





1x



1x



1x

# 29



1x



1x

# 30

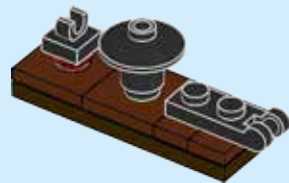

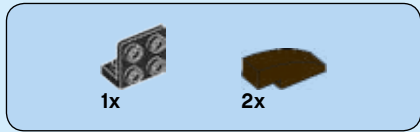

**31**

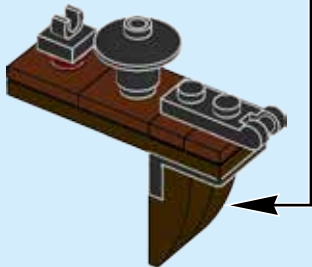
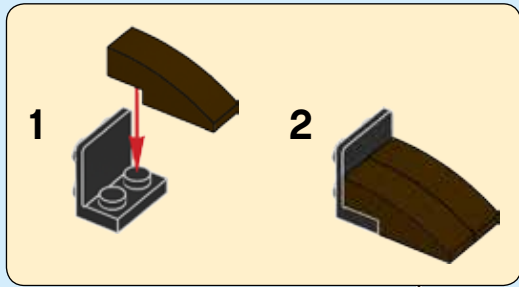

**32**

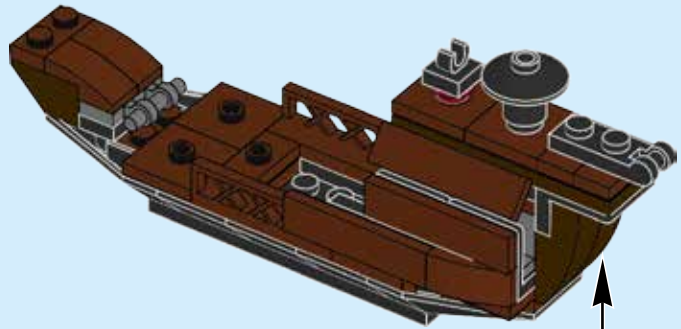



**33**

**1**



**2**

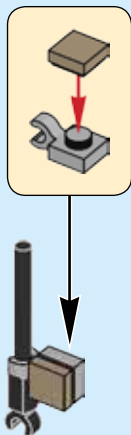

**3**

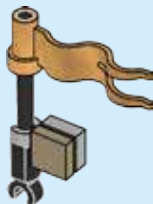

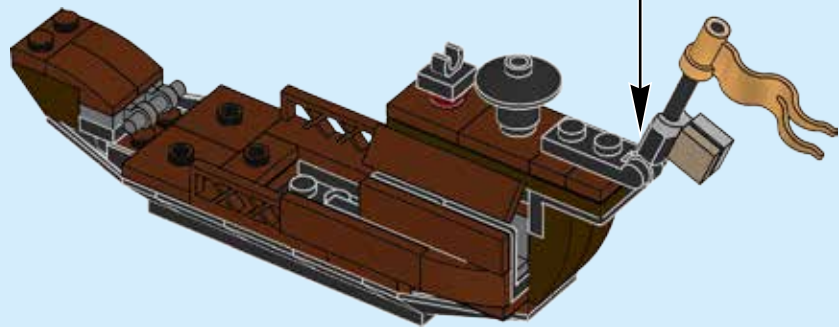





3x

34





1x



1x

35

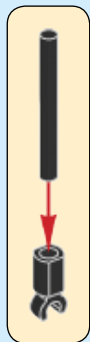



1x



1x

# 36



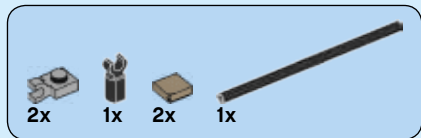

37

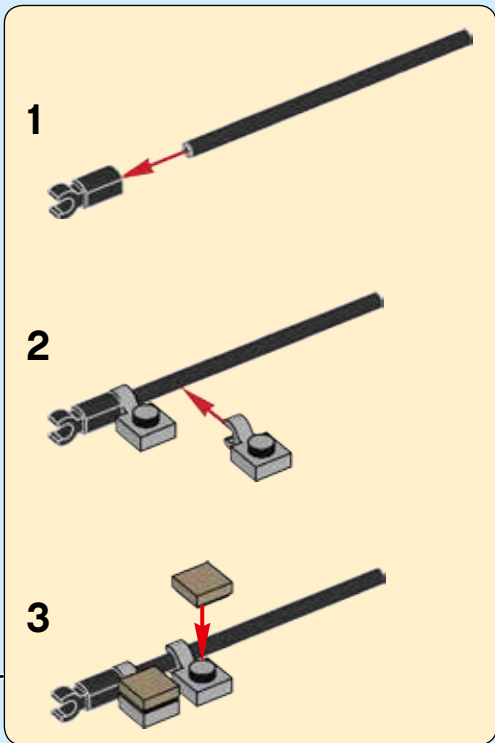
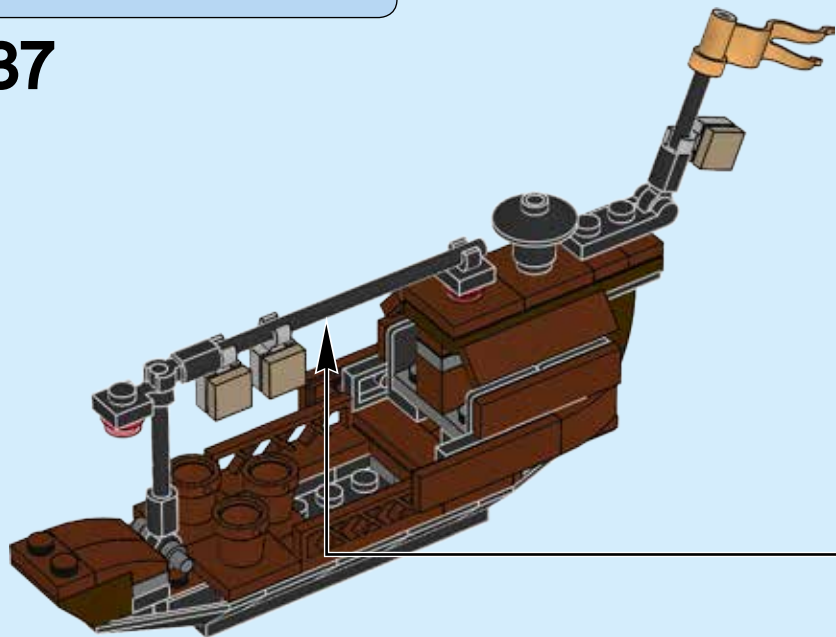

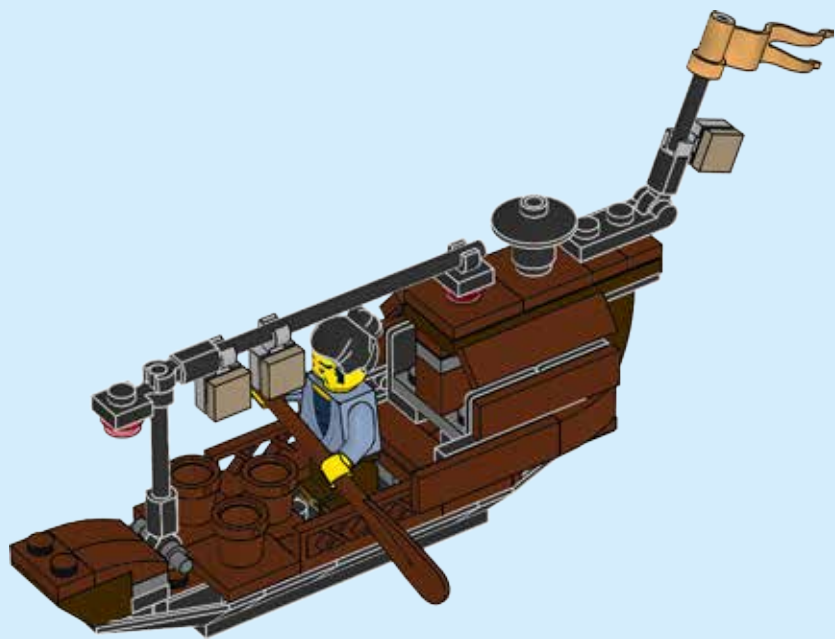



THE  
**NINJAGO**  
MOVIE

[LEGO.COM/NINJAGOMOVIE](http://LEGO.COM/NINJAGOMOVIE)





# THE NINJAGO MOVIE

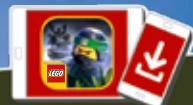

LEGO® WU-CRU  
[LEGO.com/apps](http://LEGO.com/apps)



[LEGO.COM/NINJAGOMOVIE](http://LEGO.COM/NINJAGOMOVIE)





# THE NINJAGO MOVIE



70606



70607



70608



70609



70611

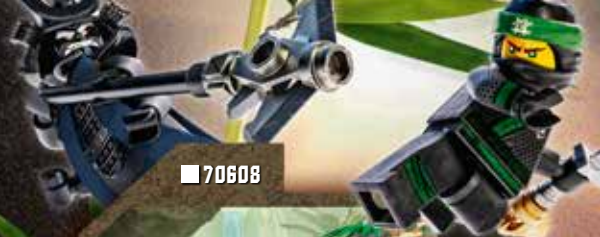



70612



70614



70618



70615



70617





# THE NINJAGO MOVIE

## VIDEOGAME



**7**<sup>TM</sup>  
www.pegi.info  
PROVISIONAL

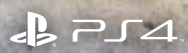

[LEGO.com/videogames](http://LEGO.com/videogames)





**LEGO**



**WORLDS**

UNLOCK MODEL IN GAME / Separate purchase required  
MODELL IM SPIEL FREISCHALTEN / Separater Kauf erforderlich  
DÉBLOQUEZ LE MODÈLE EN JEU / Achat séparé requis  
SBLOCCA MODELLO NEL GIOCO / Da acquistare separatamente  
DESBLOQUEAR MODELO EN EL JUEGO / A la venta por separado  
DESBLOQUEAR MODELO NO JOGO / É necessária compra em separado  
MODELL KIOLDÁSA A JÁTÉKBAN / Külön vásárlás szükséges  
在游戏里解锁模型 / 需分开购买

PPA72V



LEGO THE MINIFIGURE MOVIE





































































7

www.pegi.info  
PROVISIONAL

TT GAMES  
LEGO GAMES

LEGO WORLDS software © 2017 TT Games Ltd. Produced by TT Games under license from the LEGO Group. LEGO, the LEGO logo, the Brick and the Knob configurations and the Minifigure are trademarks of the LEGO Group. © 2017 The LEGO group. All other trademarks and copyrights are the property of their respective owners. All rights reserved. WB GAMES LOGO, WB SHIELD: ™ & © Warner Bros. Entertainment Inc. (s17)

LEGO.com/worlds

 3x 4626196	 7x 4211194	 6x 6020189	 1x 4222192	 1x 4211065	 1x 6192758	 4x 4211483	 2x 4211029
 1x 6021336	 2x 6192371	 1x 6194290	 6x 4211094	 1x 4600437	 1x 6192565	 2x 6071229	 1x 6195495
 1x 6021339	 2x 4211186	 6x 6115080	 3x 4211133	 1x 4243831	 1x 6191864	 2x 4211375	 1x 4616840
 4x 6069984	 1x 6159763	 2x 4210655	 1x 4568734	 4x 4243831	 1x 6195487	 2x 4541978	 2x 4211815
 12x 6092590	 1x 4609635	 1x 4210631	 2x 6086709	 4x 4222042	 1x 4648296	 2x 4529241	 2x 4520320
 1x 4211149	 2x 6034044	 2x 4210762	 6x 6000606	 8x 6166865	 2x 6022199	 2x 4211551	 2x 4211396
 4x 4211150	 2x 4613762	 1x 4211087	 1x 4549886	 12x 6166868	 1x 4518687	 2x 6192577	 1x 6105964
 1x 6075208	 1x 6132212	 1x 4210660	 1x 4211097	 4x 6166870	 1x 6192605	 2x 6043656	 1x 4211725
 4x 4565394	 2x 4210639	 1x 6174161	 1x 6039176	 1x 6195406	 1x 6192605	 8x 4654582	 1x 4211462



2x  
6088638



2x  
6089119



1x  
4515368



2x  
371026



3x  
4188534

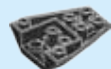

2x  
6092952



1x  
6193640



2x  
303426



2x  
6116604



2x  
614326



4x  
4121715



1x  
6191921



2x  
6006140



4x  
302326



2x  
393826



2x  
393726



5x  
6000650



13x  
4556158



3x  
6015891



1x  
306226



2x  
6121485



1x  
6066102



1x  
654126



1x  
6099429



1x  
6173926



1x  
6191714



1x  
4550017



1x  
474026



2x  
6057397



8x  
4206482



6x  
4650498



1x  
626440



2x  
6192645



3x  
4497943



2x  
3005741



4x  
6055172



2x  
6195347



1x  
4504649



3x  
6162578



4x  
4216656



1x  
243224



2x  
306224



1x  
6191858



1x  
6194799



1x  
6192818



1x  
6195253



6x  
6014033



2x  
4169960



2x  
74156



2x  
6168644



12x  
302324



2x  
4515367



1x  
300224



1x  
371024



1x  
4515349



2x  
6100888



1x  
6178629



3x  
6121436



2x  
4646865



8x  
4278409



4x  
6132438



**Customer Service**

**Kundenservice**

**Service Consommateurs**

**Servicio Al Consumidor**

**LEGO.com/service or dial**



**: 00800 5346 5555**

**: 1-800-422-5346**





THE LEGO NINJAGO MOVIE ©  
& ™ Warner Bros. Entertainment  
Inc. & The LEGO Group. LEGO,  
the LEGO logo, NINJAGO and the  
Brick and Knob configurations  
are trademarks of the/son des  
marques de commerce du/son  
marcas registradas de LEGO Group.  
©2017 The LEGO Group. All rights  
reserved/Tous droits réservés/  
Todos los derechos reservados.  
(s17)



BILLUND • DEUTSCHLAND  
WINDSOR • MALAYSIA

**EXCLUSIVELY • EXKLUSIV • EXCLUSIVEMENT • EN EXCLUSIVA • ESCLUSIVO  
EXCLUSIVAMENTE • KIZÁRÓLAGOSAN • 独家所有 • EKSKLUSIVT • ここだけの特典 • ÖZEL**



Manchester • Berlin • Oberhausen  
Istanbul • Osaka • Shanghai • Tokyo



LEGO, the LEGO logo, the Brick and Knob configurations, NINJAGO, the Minifigure and LEGOLAND are trademarks of the LEGO Group.  
©2017 The LEGO Group. LEGOLAND is part of Merlin Entertainments plc.

**LEGOLAND.COM**

6207801